



XinNanTian International (HongKong) co.,LTD
ShenZhen XinNanTian Technology co.,LTD

Shenzhen XinNanTian Technology

Version C
Apr. 18 2016

全力打造高端品牌XNT连接器
To create high-end brand XNT connector
TF/SIM/HDMI/POGO PIN/FPC/耳机座/USB系列按键系列线材





History:

** Version A -----New issue

20150922

** Version B -----Update Lab equipment

20160219

** Version C -----Update turnover and customer

20160418





Summary:

1. 工厂概况	3-4页
2. 工厂组织架构	5页
3. 品质组织架构	6页
4. 产品研发系统	7-10页
5. 品质控制系统	11页
6. 实验设备	12-16页
7. 生产设备	17-19页
8. 工厂认证	20页
9. 产品介绍	21-28页
10. 公司网站	29页
11. 主要客户	30页



1:工厂概况

- 公司成立于2007年;
- 2007年深圳市鑫南天科技有限公司成立
- 2008年塑胶分部
 深圳市东毅欣电子有限公司成立
- 2010年台湾分部:
 台湾川富精密有限公司成立
- 2014年国际贸易部:
 鑫南天国际(香港)有限公司成立
- 注册资本: RMB100万
- 业务范围: 连接器设计及制造销售, OEM&ODM
- 生产能力: 400kpcs/天
- 客户群: 200多个
- 产品种类: 约1000个产品
- 去年销售额: 5500万
- 产品覆盖: microSD conn.;SIM conn.;SD conn.; microS
Nano sim conn.; HDMI c type ; microUSB B F; FPC; PO





1:工厂概况

深圳总公司

深圳市鑫南天科技有限公司

地址：深圳市宝安区福永镇大洋田正中工业园

台湾分公司

台湾川富精密电子有限公司

地址：台湾桃园市观音区仑坪工业区仑坪1-34号

光明分公司

深圳市东毅欣电子有限公司

地址：深圳市光明新区公明街道李松朗社区第一工业区

香港分公司

鑫南天國際（香港）有限公司

地址：香港九龙旺角道33号凯途发展大厦7楼





2:工厂组织架构

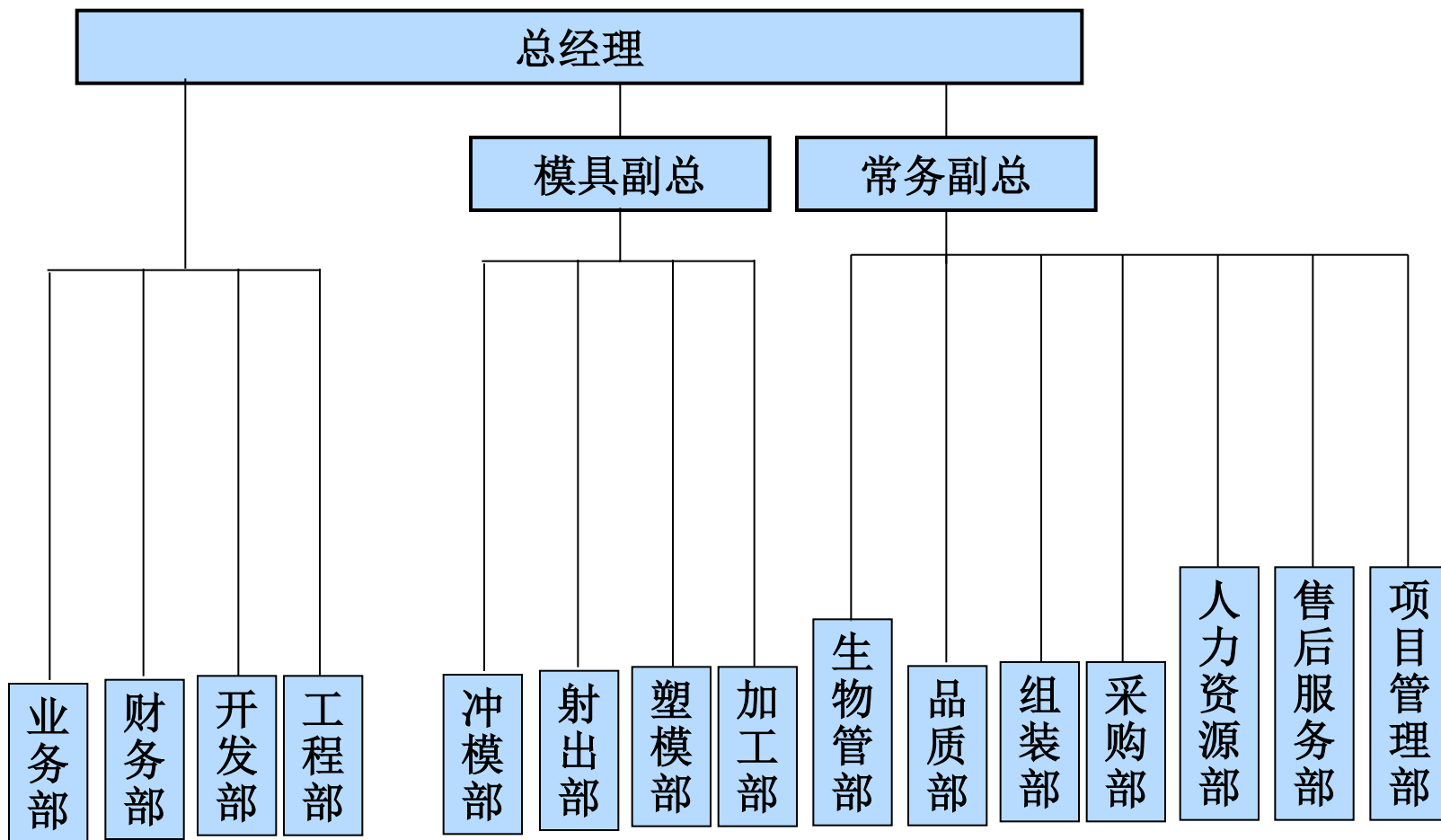



3:工厂品质架构

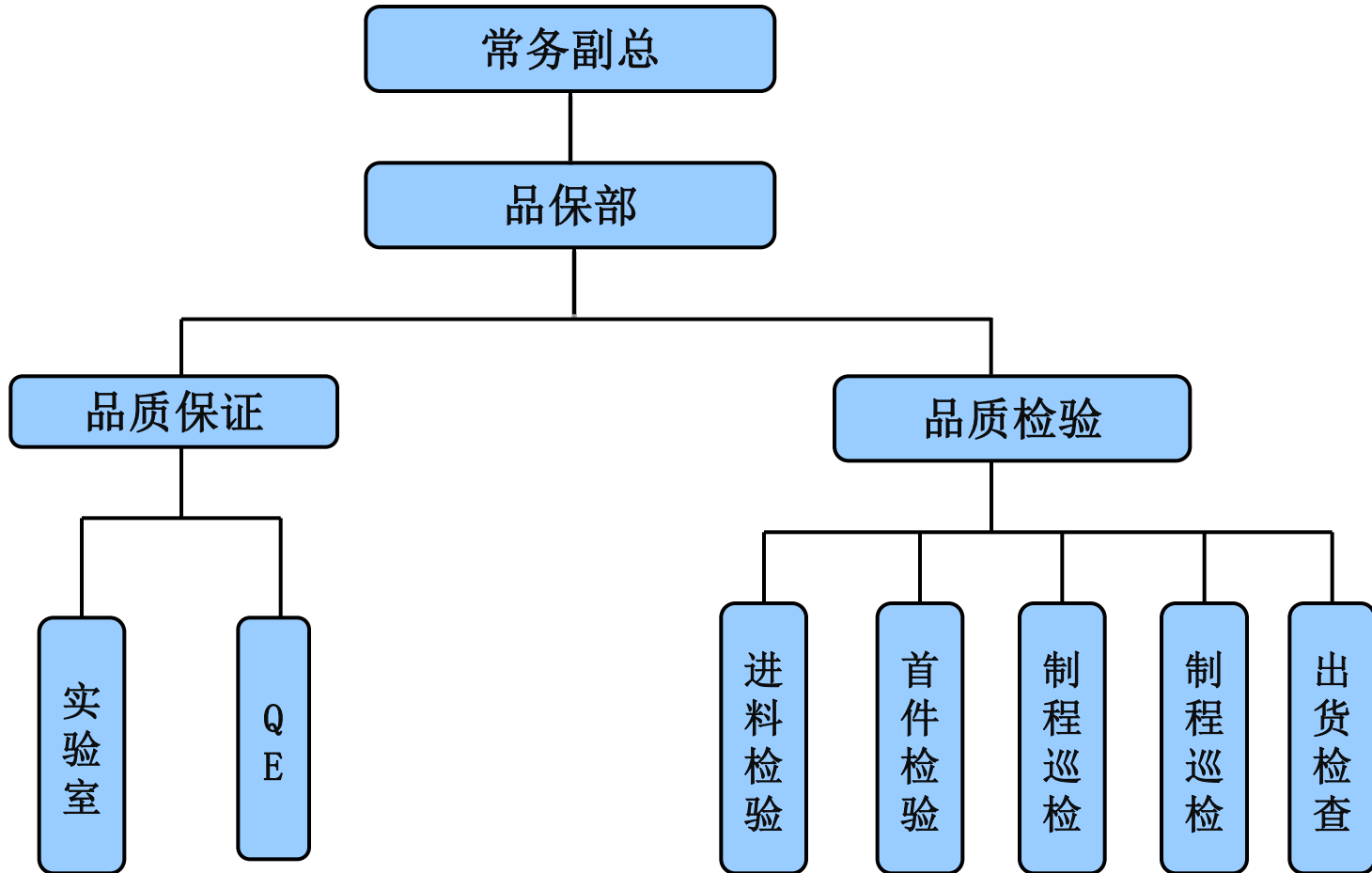



4: 研发系统

R&D 研发系统

- 4.1 可行性评估
- 4.2 3D设计+3D模拟分析
- 4.3 设计审查
- 4.3 2D 二维设计 (AutoCAD)
- 4.4 冲压成型模具设计
- 4.5 自动化设计
- 4.6 样品验证
- 4.7 小批量试产
- 4.8 量产

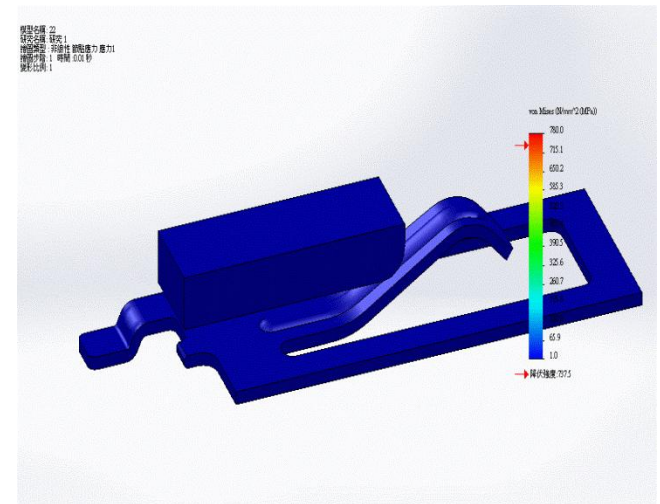
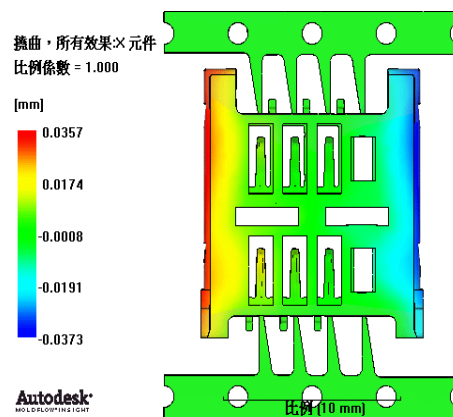
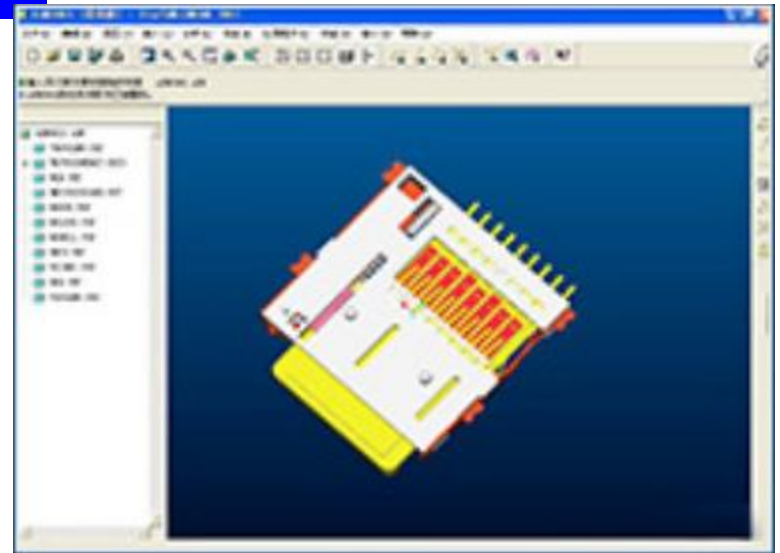



4: 研发系统

冲模设计系统

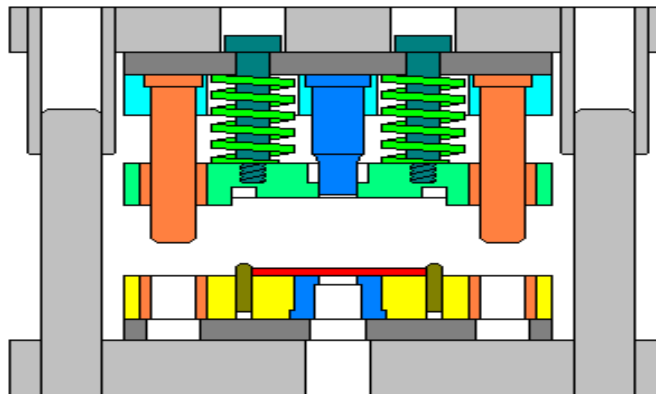

设计实现图

设计开发图

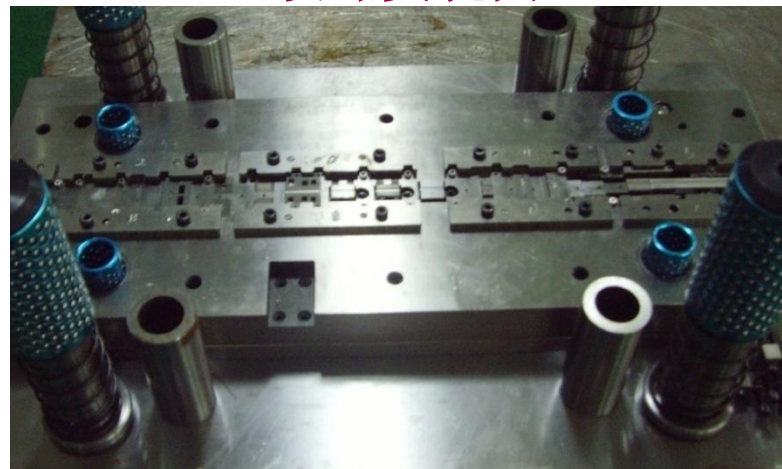
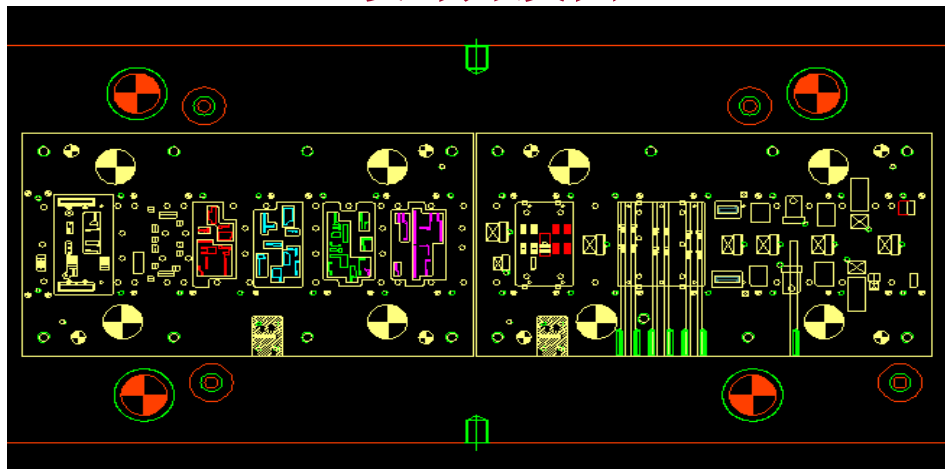

产出图

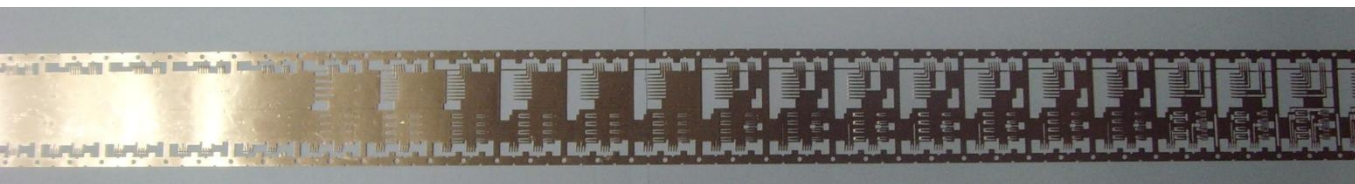



4: 研发系统

塑模设计系统

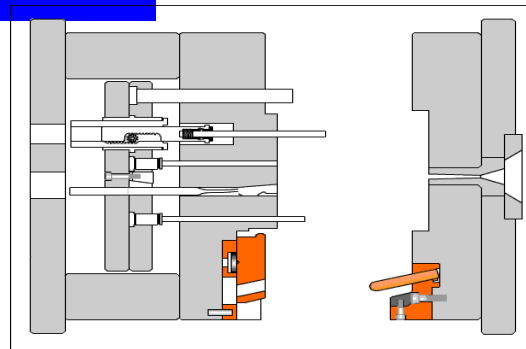

设计开发图

设计实现图

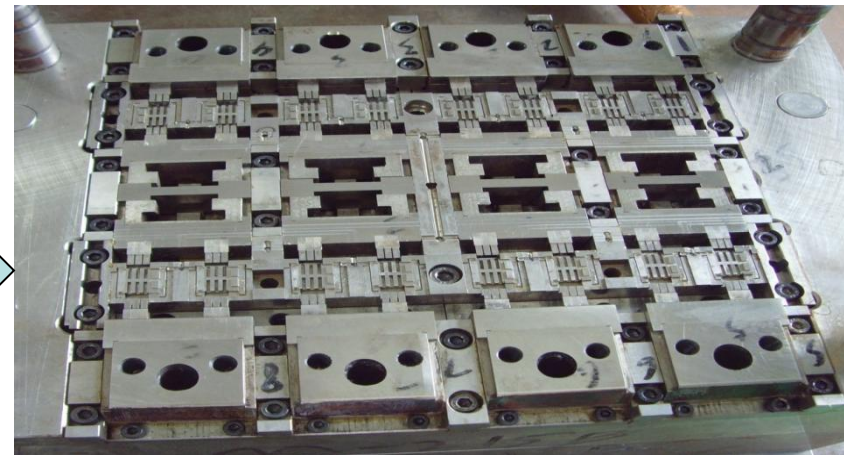
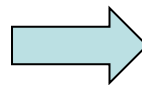
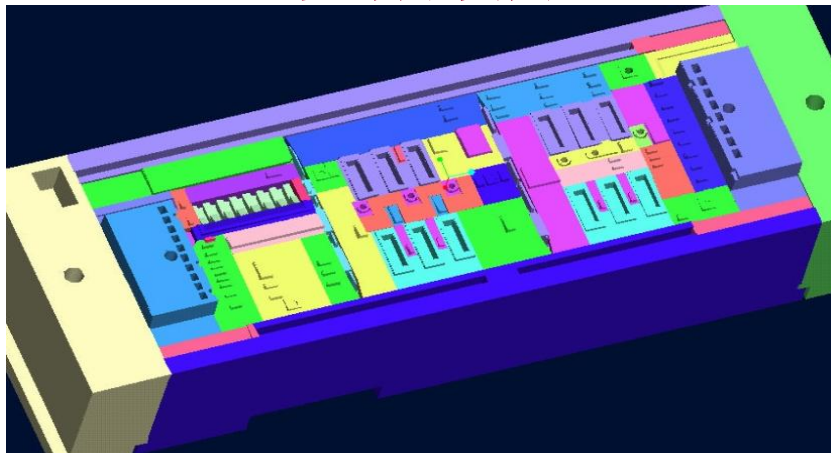

产出图

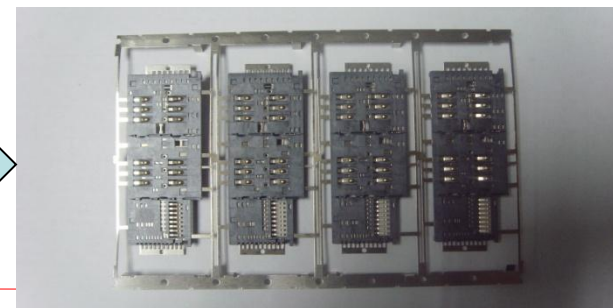



4: 研发系统

自动化研发系统

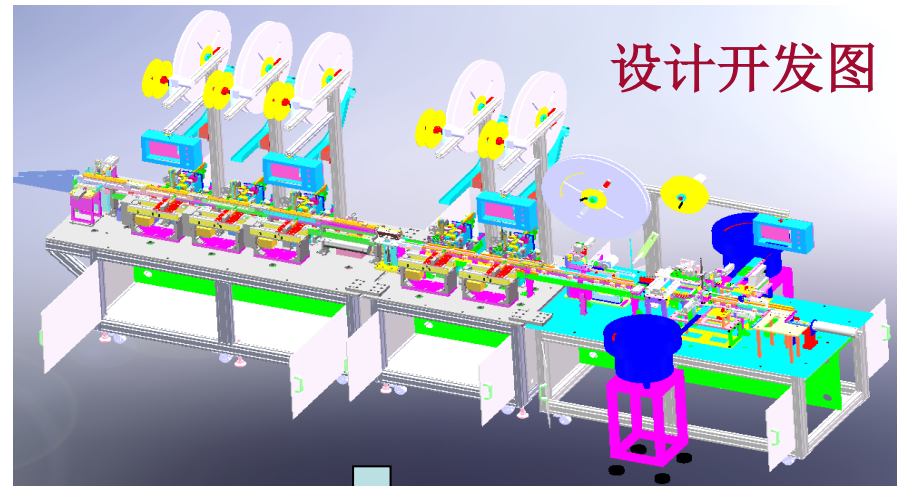

设计实现图





5: 品质控制系统

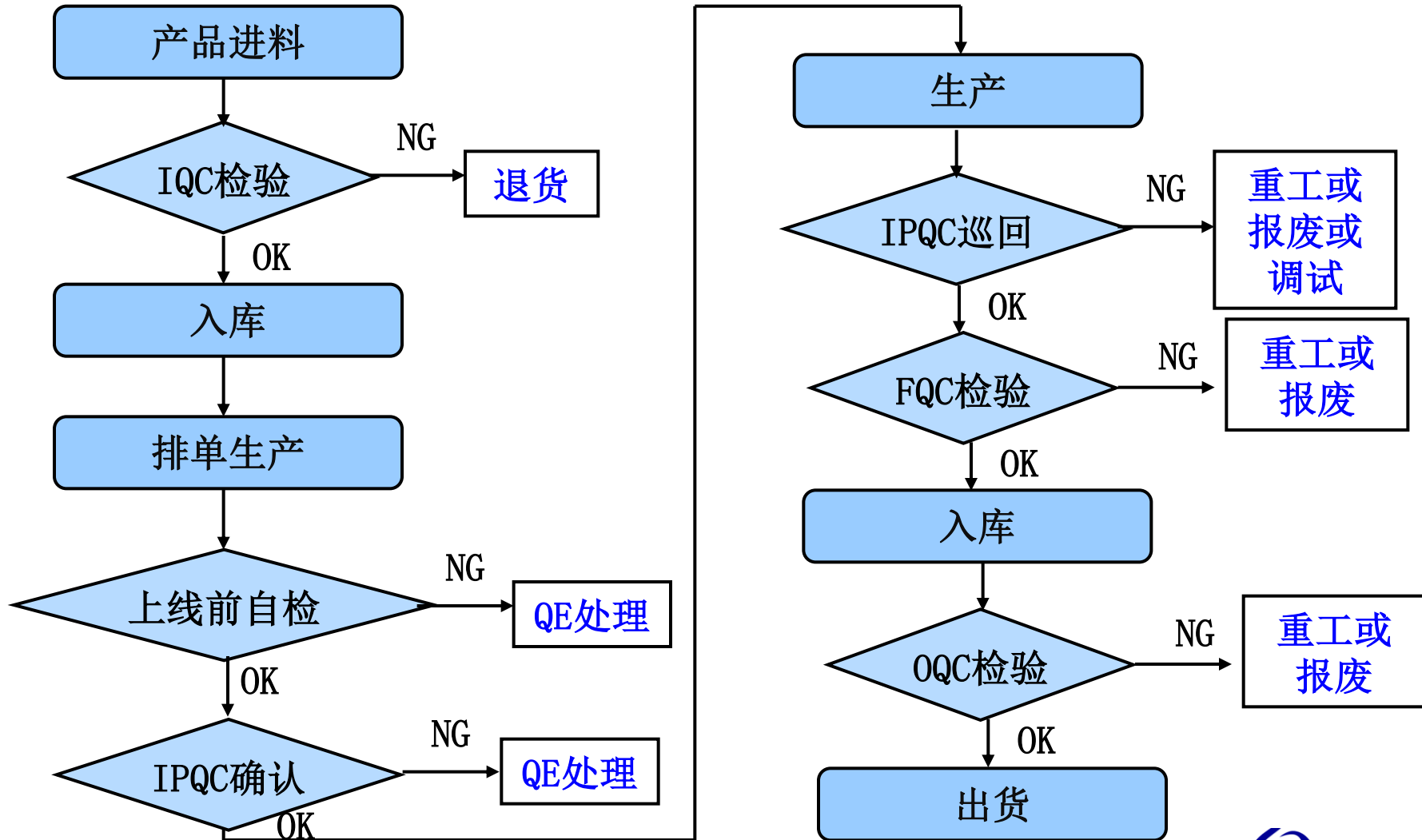



6: 实验室设备

NO.	设备名称	原产国/制造商	数量
1	接触阻抗仪	中国/忠信仪器 SJ2511	1
2	电烙铁	中国/Dingke 936A	1
3	风枪	中国/友益达	1
4	耐高压测试	中国/Sunjct 7122	1
5	耐久测试机	中国/鑫南天自制	1
6	烤箱	中国/焕煌101-1	1
7	插拔力测试仪	台湾/Sundoo SN-500	1
8	IR回流焊	中国/科士达 RF430	1

NO.	设备名称	原产国/制造商	数量
9	盐雾实验机	中国/H2040	1
10	二次元	China/长安力准 : CW-107V	2
11	锡炉	中国/创美威 CM350A	1
12	显微镜	中国/XTJ-4000	1
13			
14			
15			
16			





6: 实验室设备

Electrical Test

Contact Resistance

Insulation Resistance

Withstanding Voltage Test

Mechanical Test

Mating & Unmating

Durability

Contact Normal Force

Contact Retention

Vibration

Mechanical Shock

Environmental Test

Thermal shock

Humidity Test

Temperature Life

Salt spray

Solder ability

Solder Heat Resistance





6: 实验室设备



投影仪



蒸气老化仪



6: 实验室设备



I.R. 炉



二次元影像仪



高压测试仪



接触阻抗

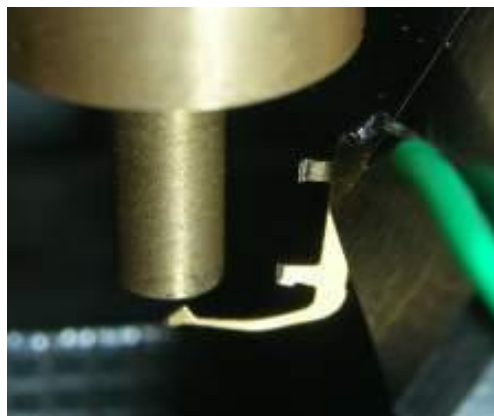

插拔力测试



耐久测试机



6: 实验室设备

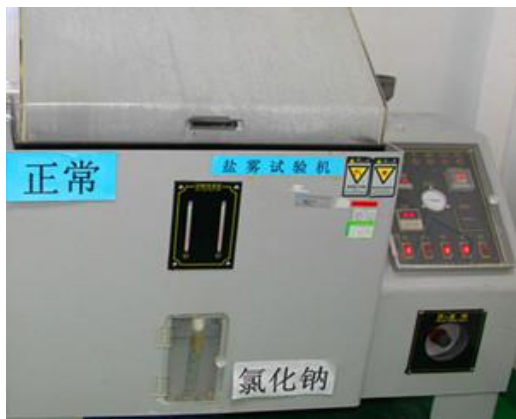

盐雾测试机



锡炉

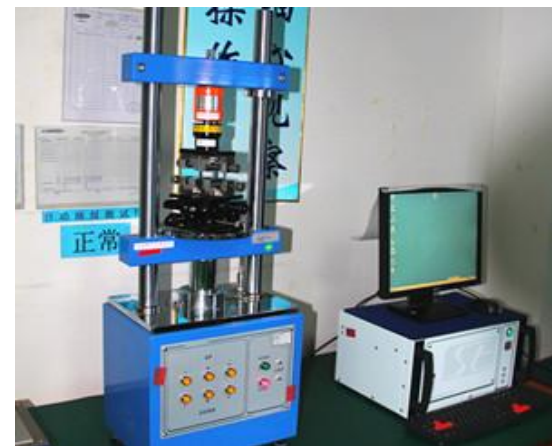

拉拔力测试仪



显微镜

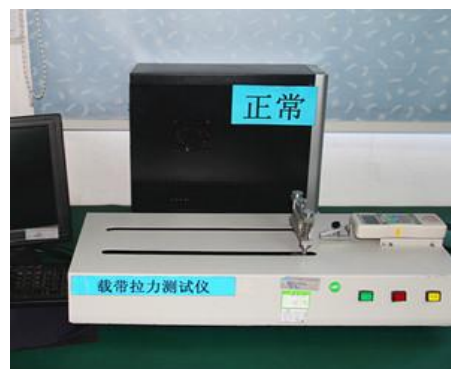

剥离力测试仪



高温烤箱



7:生产设备



高速冲床 24 sets



注塑机 18 sets

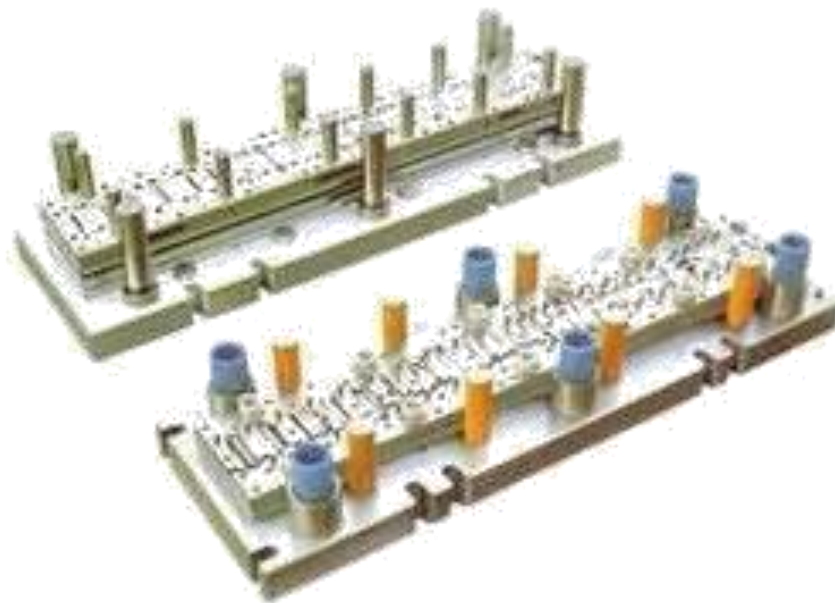



7:生产设备



生产线 10条



7:生产设备



快走丝2台



铣床5台



磨床18台



EDM 2台



8:工厂认证

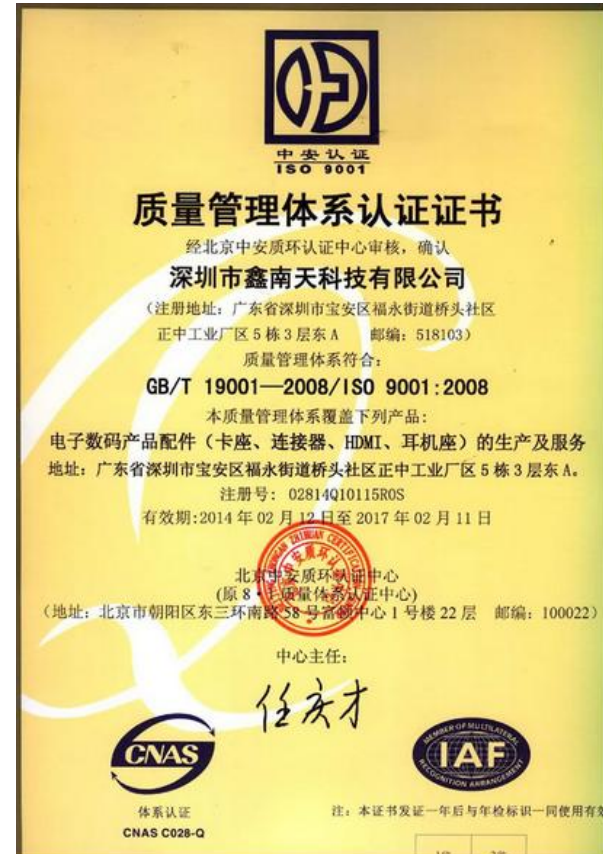



9: 产品介绍

microSD connector

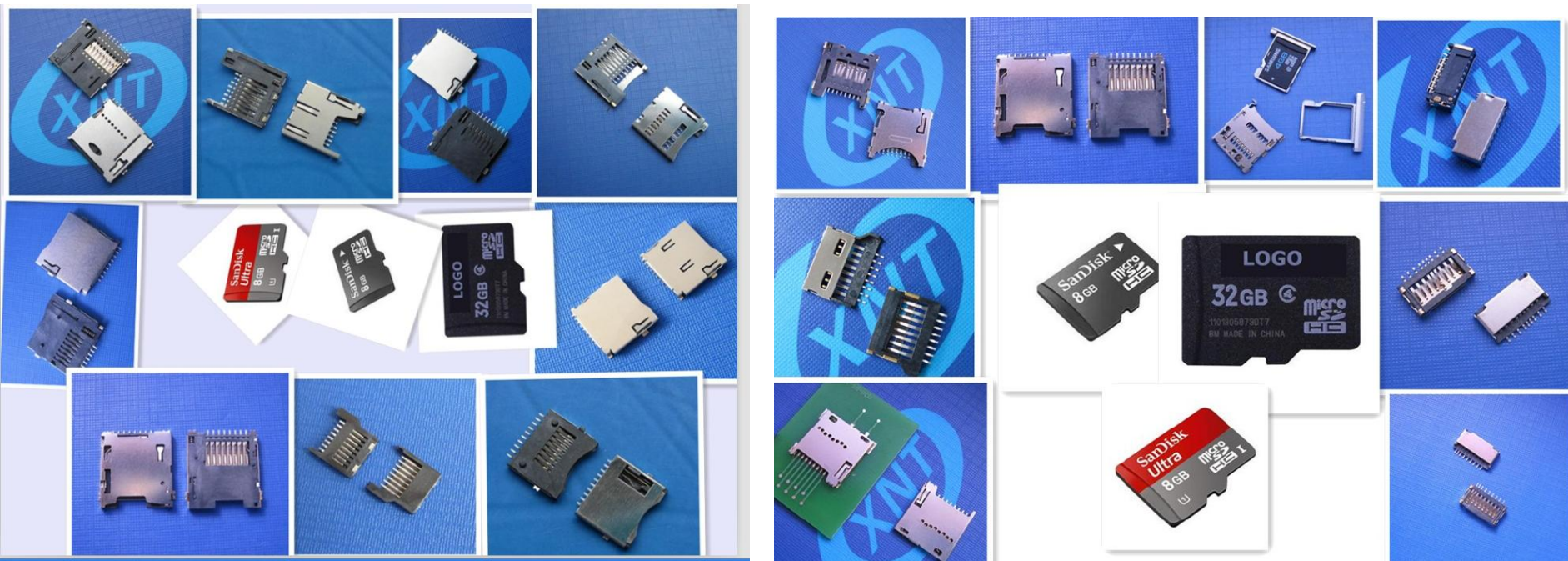



9: 产品介绍

SIM connector





9: 产品介绍

Micro SIM connector



Nano SIM connector

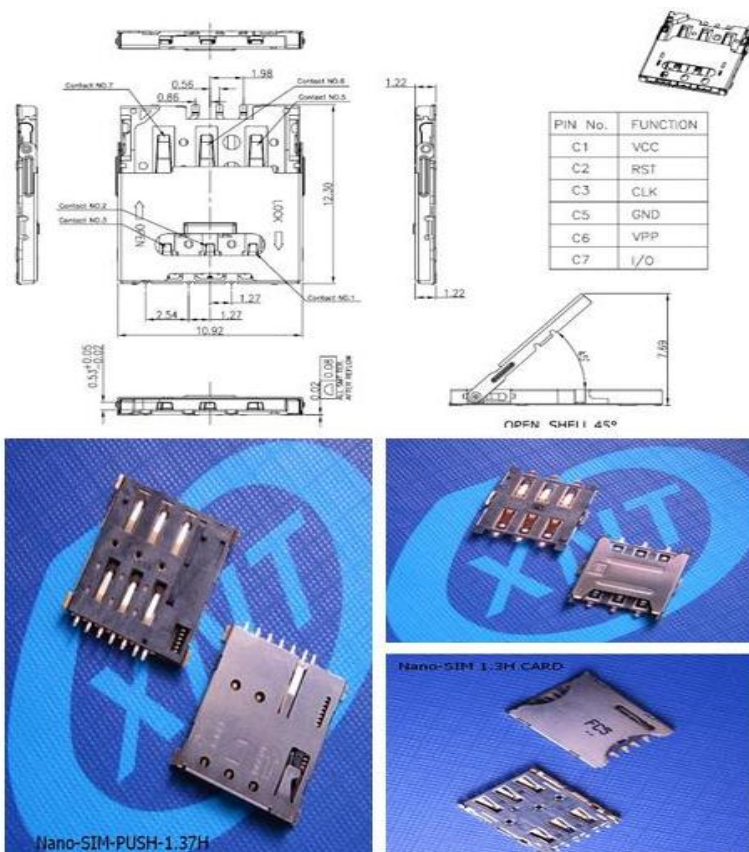



9: 产品介绍

HDMI 系列 (A型, C 型, D型)



microUSB B型





9: 产品介绍

microUSB B型

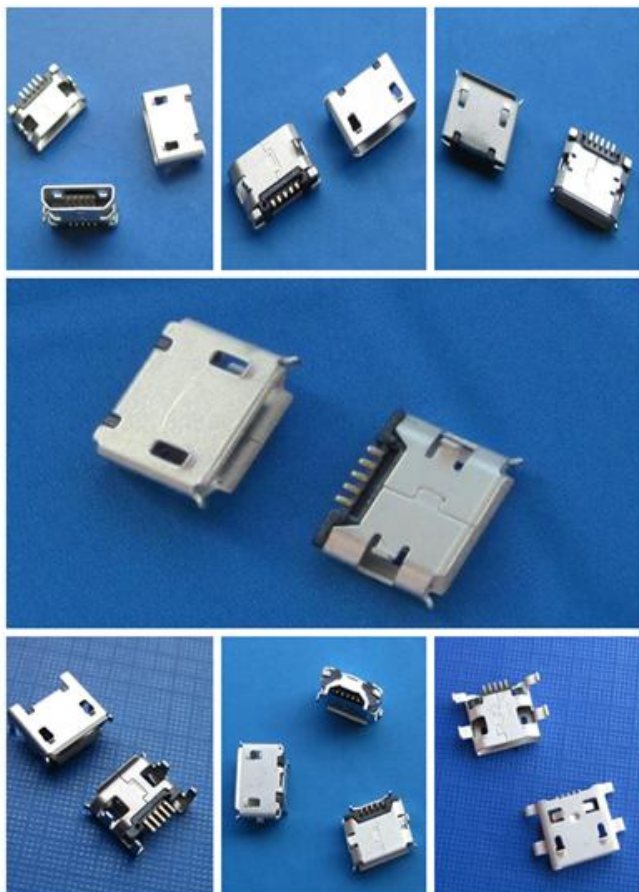

Mini USB





9: 产品介绍

USB A型



Phone Jack

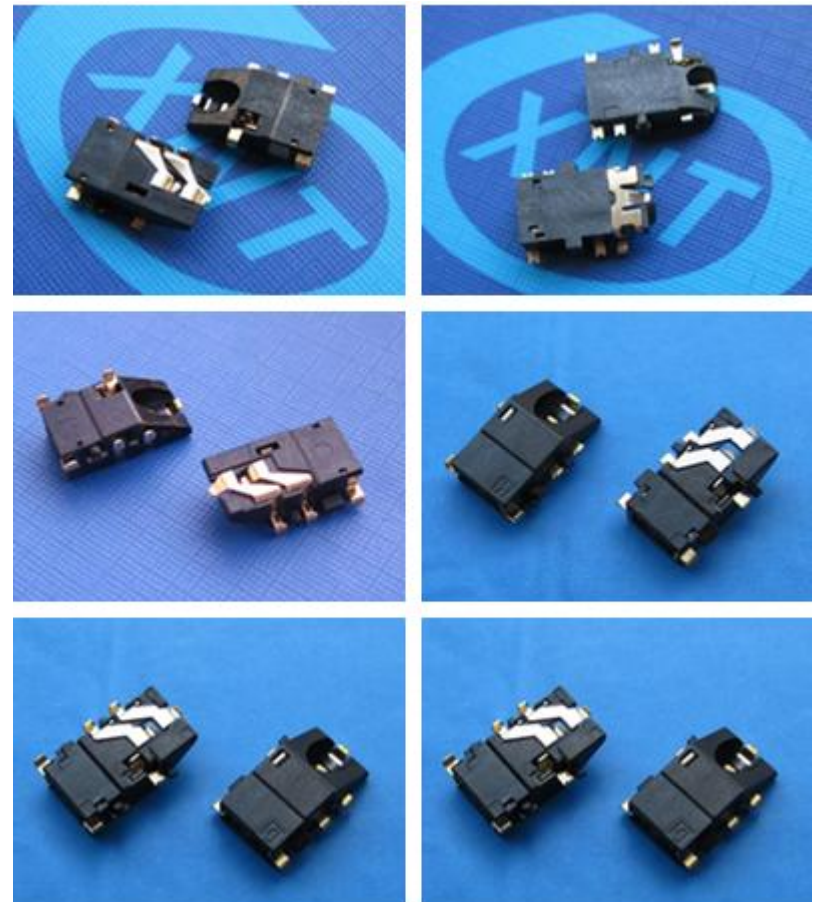



9: 产品介绍

Tactile Switch



POGO pin

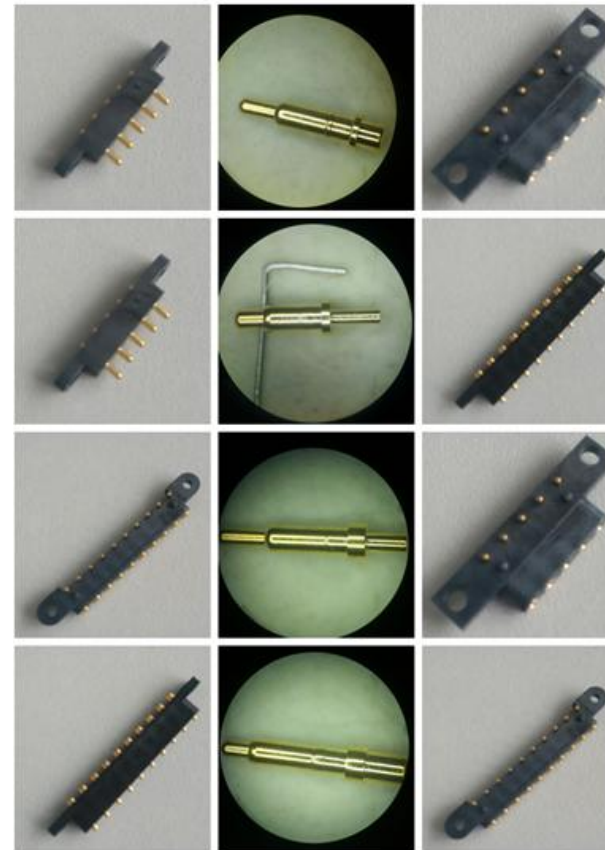



9: 产品介绍

弹簧和冲压件



电池弹簧



卡托



不锈钢外壳



连续外壳



弹簧



通讯弹簧 (天线)

塑胶件

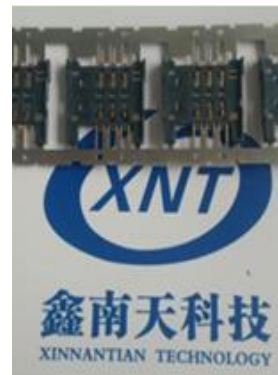
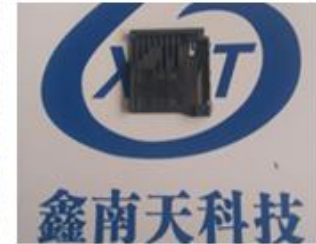
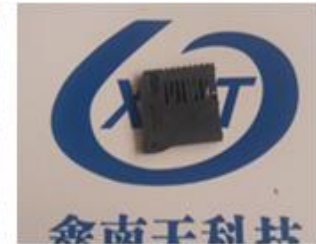



9: 产品介绍

按图加工模具

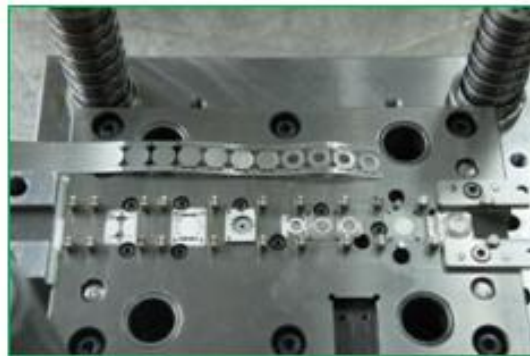



10: 公司网站

公司网站: <http://www.szxnt.com>

阿里巴巴中文网: <http://szxinnantian.1688.com>

阿里巴巴英文网: <http://sznantian.en.alibaba.com>





11:客户群



TCL



万利达
malata



TOSHIBA



THE END



全力打造高端品牌XNT连接器

To create high-end brand XNT connector

TF/SIM/HDMI/POGO PIN/FPC/耳机座/USB系列按键系列线材

