

NOTES:

1. MATERIAL:
 - 1.1 HOUSING: LCP MG-350 BPRL UL94V-0 (Supplier: JX NIPPON OIL)
 - 1.2 CONTACT: C5191 R-H 0.15T(Supplier: china-zhonghuan)
 - 1.3 SHELL: SUS304 1/2H 0.3T(Supplier: posco-gd)
2. FINISH:
 - 2.1 CONTACT: 3u"Min.Au PLATED ON CONTACT AREA
G/F PLATING ON SOLDER TAIL AREA
50~80u" NICKEL UNDERPLATING OVERALL
 - 2.2 SHELL: 80~120u" MATTTER TIN PLATING ALL
30~50u" NICKEL UNDERPLATING OVERALL
3. SPECIFICATION:
 - 3.1 CURRENT RATING: 0.5A(2.3.4CONTACT)/1.8A(1.5CONTACT) MAX.
 - 3.2 VOLTAGE: 30VAC
 - 3.3 TEMPERATURE RANGE: -30 °C ~ 85 °C
 - 3.4 CONTACT RESISTANCE: 30 MILLIONHM MAX
 - 3.5 DIELECTRIC WITHSTANDING VOLTAGE: 250 VAC r.m.s
 - 3.6 INSULATION RESISTANCE: 100 MEGOHMS MIN.

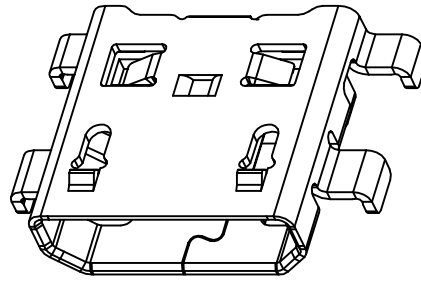

3D VIEW

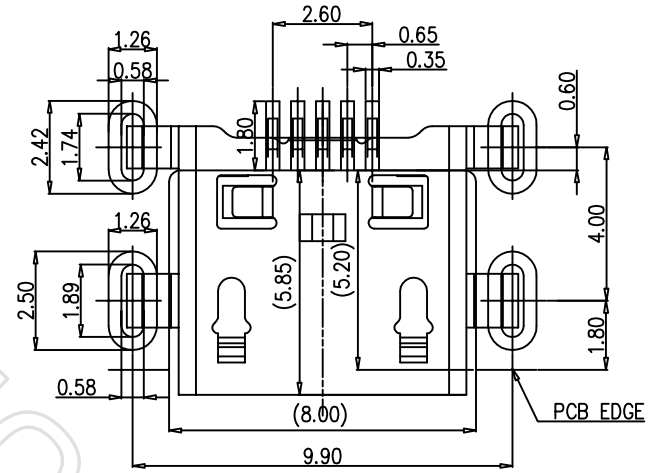
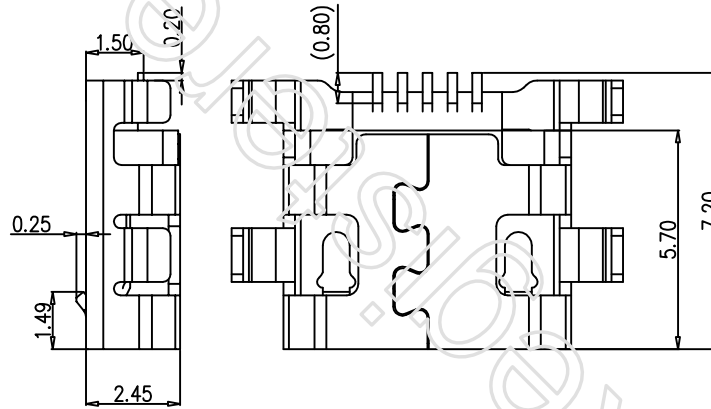

RECOMMENDED PCB LAYOUT(TOP VIEW)

GENERAL TOLERANCES: ±0.05

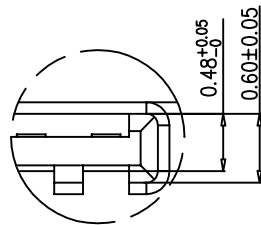
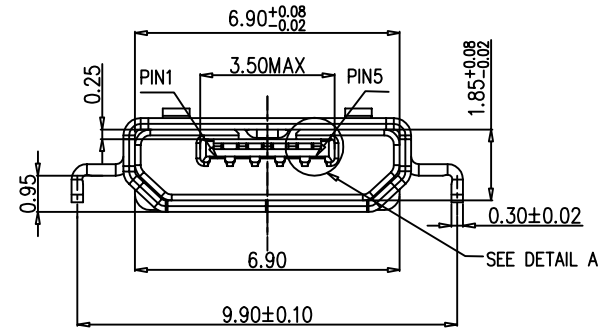
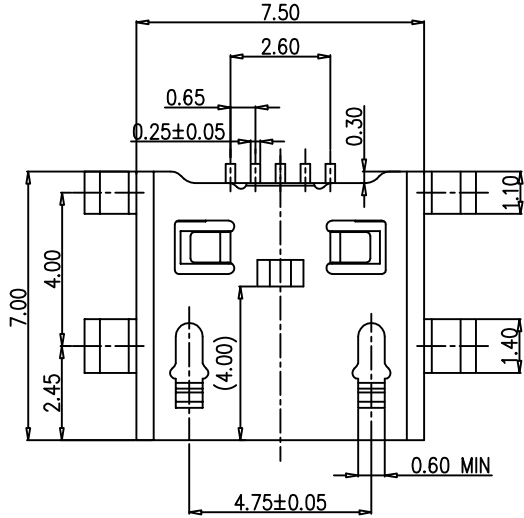
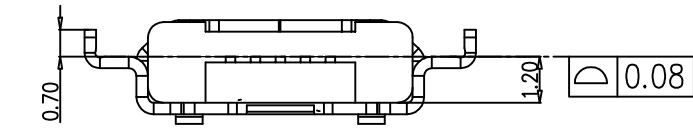

DETAIL A
SCALE 3:1

		深圳市鑫南天科技有限公司 Shen zhen Shi Xin Nan Tian Industrial Co., Ltd		
		PRODUCT NAME : MICRO USB 5PIN 沉板0.95 四脚插板 长7.0 平口	DRAWING: COCO	DATE: 2008/12/10
DIMENSIONS INIT: mm UNLESS OTHERWISE SPECIFIABLE		PRODUCT NO. : MICRO5PCB095L7PK	CHECK: JANY	DATE: 2008/12/10
DIMENSION TOLERANCE X.X: ± 0.25 X.XX: ± 0.10 X.XXX: ± 0.05 ANGULAR: ± 1°		DRAWING NO. : XNT-070	APPROVED: JEFF	DATE: 2008/12/10
X1 REV.		SCALE: 1:1	DWG ID: P D	REV.: B
				PAGE: 1 of 1

由 Autodesk 教育版产品制作

由 Autodesk 教育版产品制作